



EUUCO WATERSTOP PVC

FLEXIBLE PVC WATERSTOP

EUCLID CHEMICAL

JOINT FILLERS & SEALANTS

DESCRIPTION

EUUCO WATERSTOP PVC is extruded from specially compounded PVC and is designed for use in water retaining and water excluding structures where a positive seal is required for poured in-situ concrete expansion, construction and contraction joints. **EUUCO WATERSTOP PVC** is available in different sizes and types, depending on the requirements.

PRIMARY APPLICATIONS

Water retaining structures:

- Water tanks
- Bund walls
- Sewage treatment plant
- Reservoirs
- Dams and spillways
- Water treatment plant
- Swimming pools

Water excluding structures:

- Basement areas
- Underground car parks
- Tunnels
- Retaining walls
- Suspended slabs
- Below ground slabs
- Roof slabs

FEATURES / BENEFITS

- Full range of profiles and sizes to suit all construction requirements
- Suitable for high water pressure
- High quality compounded PVC for long durability and integrity
- Easy to weld on site

TECHNICAL INFORMATION

Colour	Green
Material Type	Polyvinyl Chloride
Welding Temperatures	Approximately 180°C – 200°C

Physical Properties

PROPERTY	TEST METHOD	RESULT
Tensile strength (MPa)	ISO 37:2005	13.00
Elongation at Break (%)	ISO 37:2005	> 300
Water absorption at 32°C (%)	ISO 62:2008	0.21
Specific Gravity (g/cm ³)	BS 2782-6	1.4
Hardness, Shore A	ISO 868:2003	80
Thermal stability (minute)	BS EN 60811-3-2:1995	106
Loss of mass (g/cm ³)	BS EN 60811-3-2:1995	0.004

PACKAGING

EUUCO WATERSTOP PVC is supplied in 15m -20m rolls.

SHELF LIFE

5 years from the date of production if stored properly in original, unopened and undamaged sealed packaging in dry conditions out of direct sunlight at temperatures between +10°C and +35°C.

EUUCO WATERSTOP PVC

DIRECTIONS FOR USE

Placing of EUCO WATERSTOP PVC: Placing is executed in accordance with the engineer's drawing on which **EUCO WATERSTOP PVC** profile and the position are required. Level differences, bends, junctions, etc. should be carefully considered before placing.

Centrally Placed Waterstop

These waterstops are positioned within the thickness of the concrete components and as a result are supported by concrete on both sides. They are therefore able to withstand water pressure from either side. This makes them suitable for use in water retaining structures.

Externally Placed Waterstops

These waterstops are designed for use in basement, foundation and floor slab construction in vertical and horizontal joints in both water retaining and water excluding structures. When used in walls, externally placed waterstops will only resist water pressure from the face to which they are fixed. When used below floor slabs, where the waterstop is supported by the binding concrete or when placed in vertical situation against permanent concrete shuttering, externally placed waterstops will resist water pressure from either face.

Installation Instruction: **EUCO WATERSTOP PVC** must be installed so that it is securely held in its correct position while the concrete is being placed. Concrete must be fully compacted around the waterstop to ensure that no voids or porous area remain. Where reinforcement is present, an adequate clearance must be left to permit proper compaction.

Site Jointing Instruction: Jointing of **EUCO WATERSTOP PVC** is carried out using special heat welding equipment. The ends to be joined are cut square and held in alignment in a special jig. The ends are then pressed against either side of a special heated blade, until an even, molten bead of PVC appears around the section. The heated blade is then removed and the molten ends pressed fully together. The PVC cools to form a strong fusion welded joint.

EUCO WATERSTOP PROFILES

USES	TYPES	WIDTH, MM (+/-5 MM)	ROLL LENGTH, M
Centrally Placed Waterstops: Installation in the centre of the concrete structures			
Expansion Joints	150 EI	150	20
	200 EI	200	20
	250 EI	250	15
Construction Joints	150 CI	150	20
	200 CI	200	20
	250 CI	250	15
Surface Waterstops: Installation on the surface of concrete surfaces			
Expansion Joints	150 EE	150	20
	200 EE	200	20
	250 EE	250	15
Construction Joints	150 CE	150	20
	200 CE	200	20
	250 CE	250	15

CLEAN UP

Clean all the tools and application equipment immediately after use. Hardened and/or cured material can only be mechanically removed.

Rev: 12/01/17



EUCO WATERSTOP PVC

FLEXIBLE PVC WATERSTOP

EUCLID CHEMICAL

JOINT FILLERS & SEALANTS

EUCO WATERSTOP PVC

FOR EXPANSION JOINTS

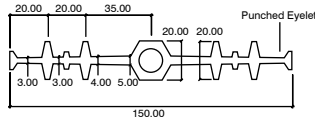

Euco Waterstop PVC 150 EI

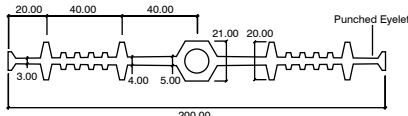

Euco Waterstop PVC 200 EI

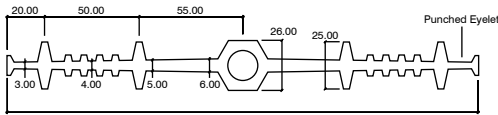

Euco Waterstop PVC 250 EI

FOR CONSTRUCTION JOINTS

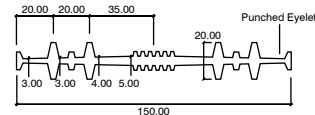

Euco Waterstop PVC 150 CI

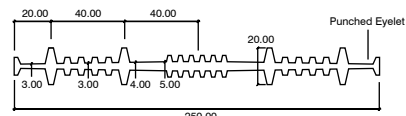

Euco Waterstop PVC 200 CI

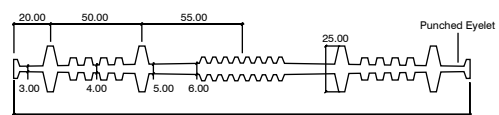

Euco Waterstop PVC 250 CI

FOR EXPANSION JOINTS

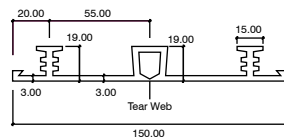

Euco Waterstop PVC 150 EE

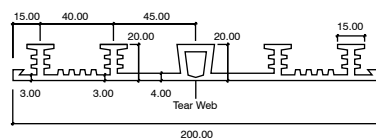

Euco Waterstop PVC 200 EE

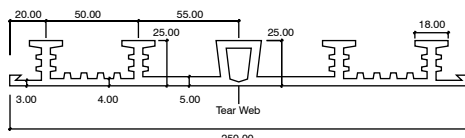

Euco Waterstop PVC 250 EE

FOR CONSTRUCTION JOINTS

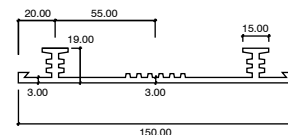

Euco Waterstop PVC 150 CE

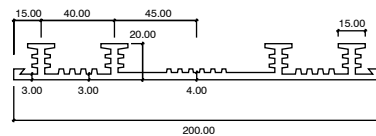

Euco Waterstop PVC 200 CE

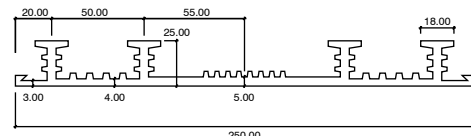

Euco Waterstop PVC 250 CE

NOTE: Full dimension drawings available upon request

TYPICAL APPLICATIONS

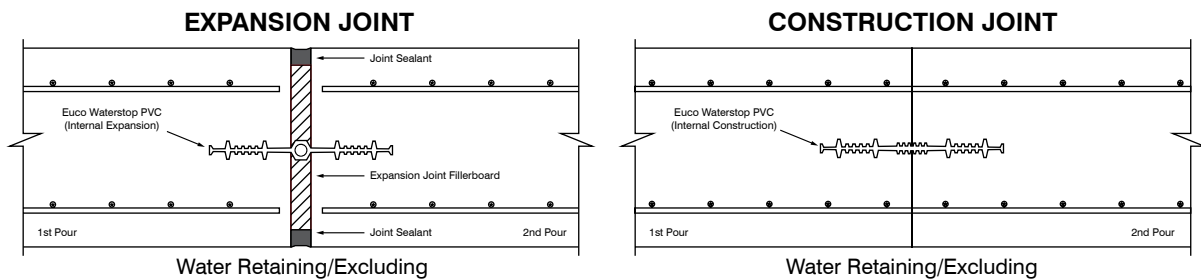

STANDARD DETAIL OF WALL APPLICATIONS

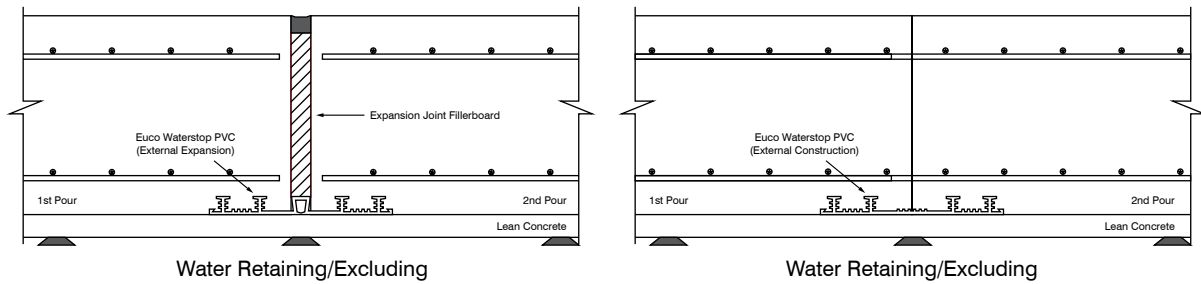

STANDARD DETAIL OF GROUND SLAB APPLICATIONS

FACTORY MADE INTERSECTIONS

A wide range of standardised prefabricated intersection pieces are available allowing easy site welding of butt joints to **EUCO WATERSTOP PVC** junction pieces. Customised pieces can be made to suit. In such cases, drawings must be provided giving exact dimensions and jointing details.

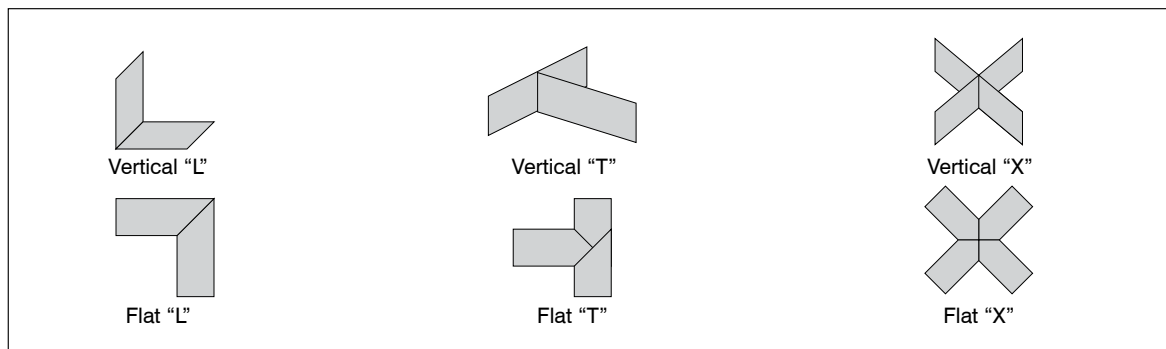

Rev: 12/01/17